

Article number: 23017751118  
 Description: E+G Handwheel  
 VR.180 FP-A18

## Measures

VR.FP-A

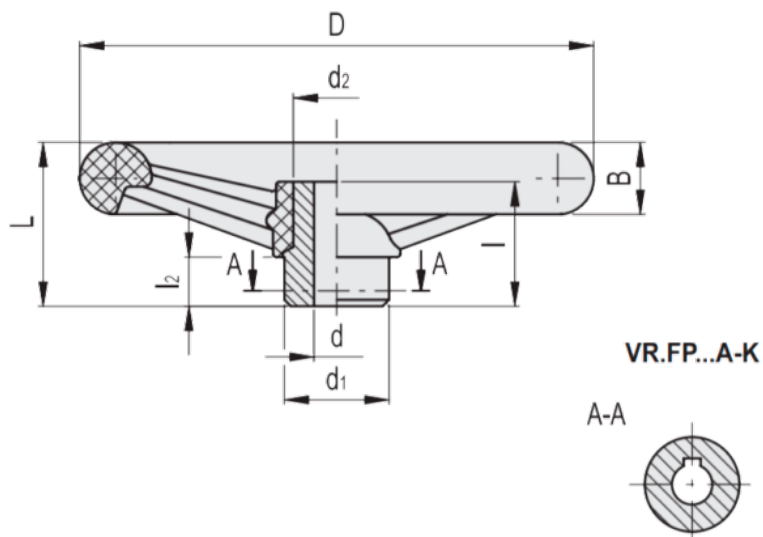

B	= 24	l	= 43
b	= 6	L	= 56
C (N*m)	= 280	L (J)	= 15
D	= 180	l2	= 15
d1	= d11	t	= 24.8
d2	= 31		
d'	= 26		
d''	= 22		